

Data Sheet

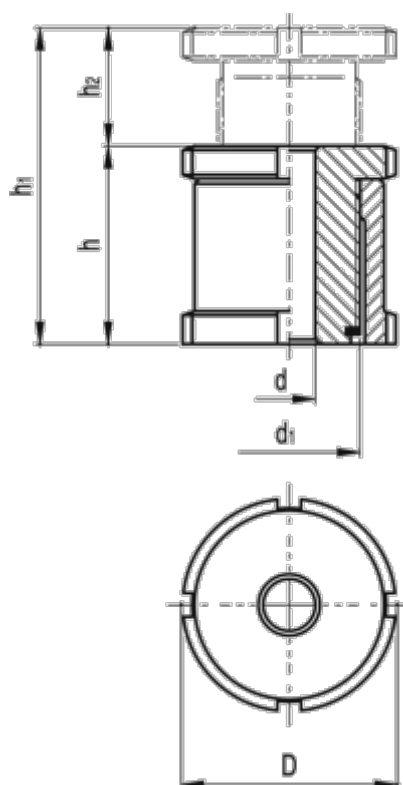

Article number: 20662214A
Description: E+G Levelling set
GN 350-45-17.5-A-NI

Measures



C-spanner DIN 1810 = A45-50
 d = 17.5
 D = 45
 d_1 = M30x1
For screw = M16
 h = 42
 h_1 = 67
 h_2 = 25

Max static load (N) = 84.0
Static preload (N) = 28.9
Weight (g) = 320